

# ROBERTS

Sound for Generations

## *ecologic 1*

DAB/FM RDS digital portable radio  
with built-in battery charger



**DAB**

Digital Audio Broadcasting



Please read this manual before use

## Contents

<i>Controls</i> .....	2-3	<i>Headphone socket</i> .....	20
<i>Battery operation</i> .....	4-5	<i>Display backlight</i> .....	20
<i>Using the AC adaptor</i> .....	6	<i>Battery information</i> .....	21-22
<i>Lock switch</i> .....	6	<i>General</i> .....	23
<i>Operating your radio - DAB</i> .....	7	<i>Specifications</i> .....	23
<i>Selecting a station - DAB</i> .....	8	<i>Circuit features</i> .....	23
<i>Secondary services - DAB</i> .....	8	<i>Guarantee</i> .....	24
<i>Display modes - DAB</i> .....	9	<i>Notes</i> .....	25-26
<i>Finding new stations - DAB</i> .....	10		
<i>Manual tuning - DAB</i> .....	11		
<i>Autoselect - DAB</i> .....	11		
<i>Dynamic range control - DAB</i> .....	12		
<i>Operating your radio - FM</i> .....	13		
<i>Manual tuning - FM</i> .....	14		
<i>Display modes - FM</i> .....	15		
<i>Presetting stations - DAB and FM</i> .....	16		
<i>Recalling a preset - DAB and FM</i> .....	16		
<i>Stereo / Mono setting - FM</i> .....	17		
<i>Scan sensitivity setting - FM</i> .....	18		
<i>Software version</i> .....	19		
<i>System reset</i> .....	19		

**Controls**  
**(Front)**

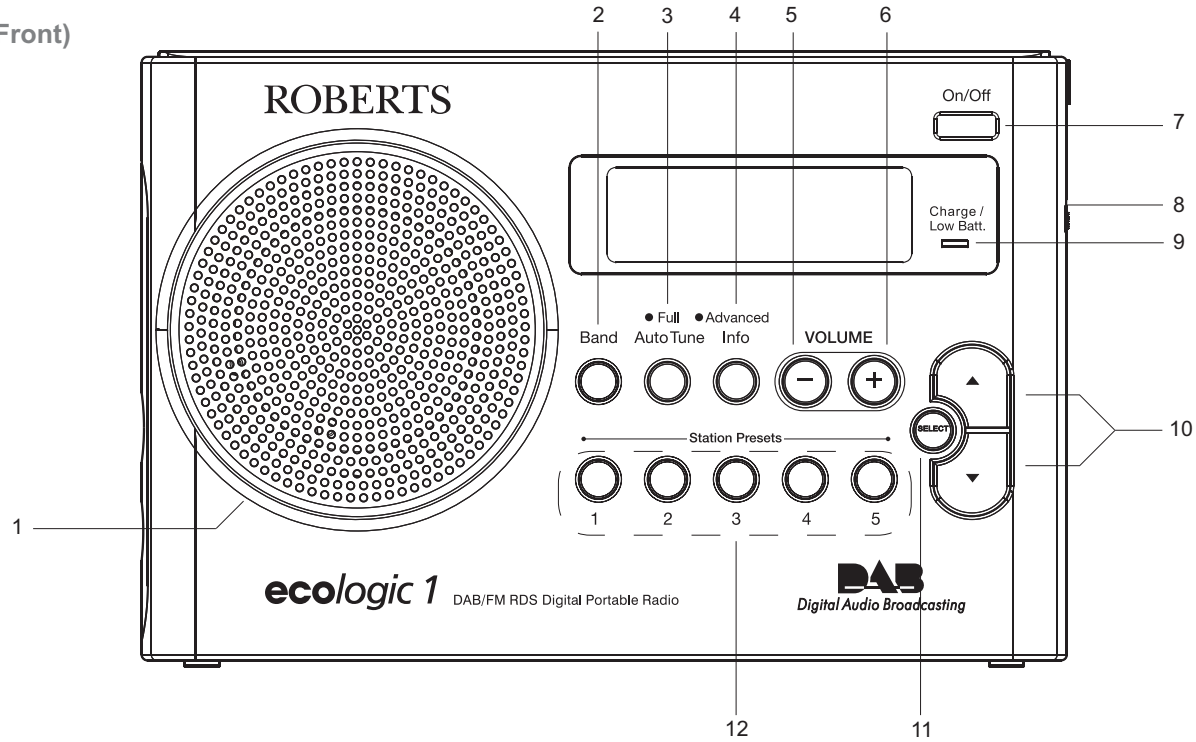

- |                     |                       |                                   |
|---------------------|-----------------------|-----------------------------------|
| 1. Speaker          | 5. Volume Down button | 9. Charge / Battery Low indicator |
| 2. Band button      | 6. Volume Up button   | 10. Tuning Up / Down buttons      |
| 3. Auto Tune button | 7. On / Off button    | 11. Select button                 |
| 4. Info button      | 8. Lock switch        | 12. Preset buttons                |

*If you need any further advice, please call our Technical Helpline on :-  
020 8758 0338 (Mon-Fri)*

Controls  
(Back)

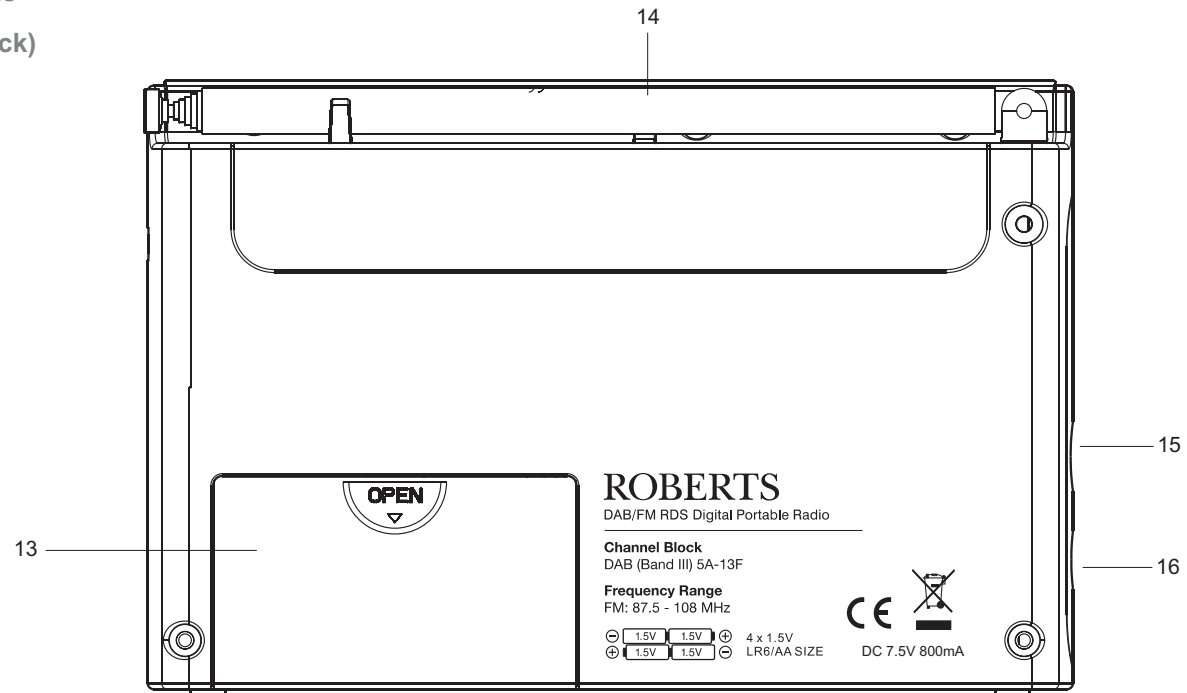

- 13. Battery compartment
- 14. Telescopic aerial

- 15. Headphone socket
- 16. DC jack socket

## Battery operation using alkaline batteries

(also see page 21)

1. Remove the battery cover on the back of the unit by sliding the cover in the direction of the arrow.
2. Slide the switch inside the battery compartment to the **Alkaline** position.
3. Insert four LR6 (AA size) alkaline batteries into the spaces in the compartment. Take care to ensure all batteries are inserted with the correct polarity as shown on the back of the radio. Then replace the battery cover.

- **Important: when using alkaline batteries the battery switch must be placed in the alkaline position. Failure to do so could result in serious damage to the batteries or radio.**
- When the batteries are exhausted, the battery light will show red for a short while. The radio will then switch itself off. It may not be possible to switch the radio back on until the batteries are replaced, or until the radio is connected to the mains adaptor.
- If the radio is not to be used for any extended period of time it is recommended that the batteries are removed from the radio.
- *We would recommend for economy that the ecologic 1 is used via the AC adaptor whenever possible with battery operation for occasional or stand-by use only. If extended listening using batteries is anticipated, then the use of rechargeable batteries is recommended.*

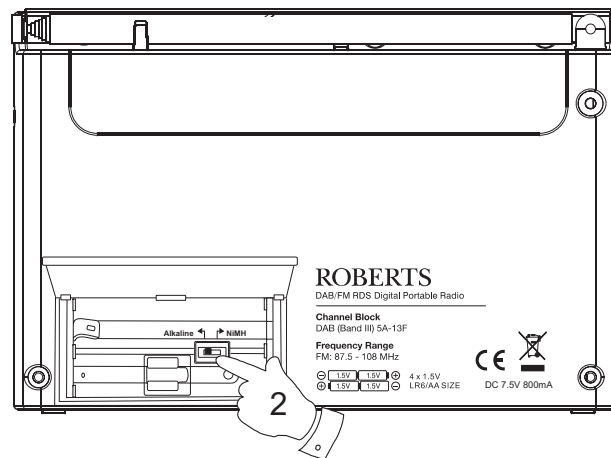

If you need any further advice, please call our Technical Helpline on :-  
020 8758 0338 (Mon-Fri)

## Battery operation using rechargeable batteries (also see page 21)

1. Remove the battery cover on the back of the unit by sliding the cover in the direction of the arrow.
2. Slide the switch inside the battery compartment to the **NiMH** position.
3. Insert four Rechargeable LR6 (AA size) batteries into the spaces in the compartment. Take care to ensure all batteries are inserted with the correct polarity as shown on the back of the radio. The radio is designed to be used with Nickel Metal Hydride (NiMH) rechargeable batteries.
4. Plug the mains adaptor into your radio and then plug the adaptor into the mains.
5. The battery light will flash green indicating batteries are charging. Batteries will be fully charged in around 7 hours. The battery light shows a steady green light when the battery charging is complete.

- **Important: when using rechargeable batteries the battery switch must be placed in the NiMH position. Batteries will only be charged when the radio is switched off and connected to the AC adaptor.**
- When the batteries are exhausted, the battery light will show red for a short while. The radio will then switch itself off. It may not be possible to switch the radio back on until the batteries are recharged, or until the radio is connected to the mains adaptor.
- If the radio is not to be used for any extended period of time it is recommended that the batteries are removed from the radio.

**IMPORTANT:** The batteries should not be exposed to excessive heat such as sunshine, fire or the like. After use, disposable batteries should if possible be taken to a suitable recycling centre. On no account should batteries be disposed of by incineration.

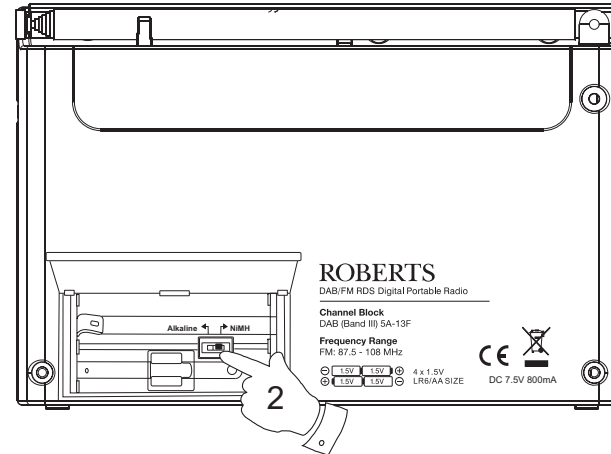

## Using the AC adaptor

Your radio is supplied with a Mains Adaptor.

1. Place your radio on a flat surface.
2. Insert the adaptor plug into the DC socket located on the left hand side of your radio.
3. Plug the adaptor into a standard 13 amp mains socket outlet. Whenever the adaptor is used with the radio, it will take power from the mains rather than from the batteries.

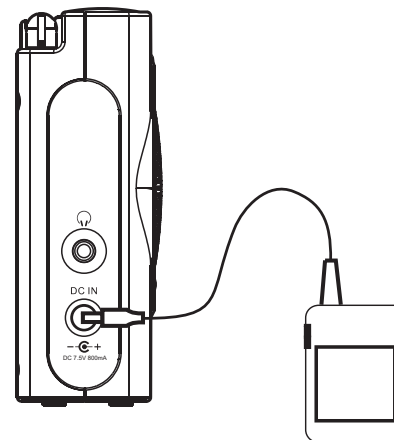

*The AC adaptor should be disconnected from the mains supply and the radio when not in use.*

- **IMPORTANT:** The mains adaptor is used as the means of connecting the radio to the mains supply. The mains socket used for the radio must remain accessible during normal use. In order to disconnect the radio from the mains completely, the mains adaptor should be removed from the mains socket outlet completely.



## Lock switch

The Lock switch is used to prevent unintentional operation of your radio.

1. Set the **Lock switch** located on the side of your radio to the 'Lock' position . The power and all other buttons will be disabled, this will prevent accidental operation when your radio is packed in a suitcase or travel bag.
2. To release the lock, slide the **Lock switch** down to the 'Unlock' position .

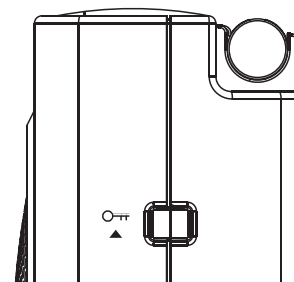

*If you need any further advice, please call our Technical Helpline on :-  
020 8758 0338 (Mon-Fri)*

## Operating your radio - DAB

1. Carefully extend the telescopic aerial.
2. Press the **On/Off button** to switch on your radio. The display will show "ROBERTS" for a few seconds and then "Welcome to DAB".
3. If this is the first time the radio is used a quick scan of the UK Band III DAB channels will be carried out. The display will show "Welcome to DAB". If the radio has been used before the last used station will be selected.
4. During the scanning process, as new stations are detected the station counter on the right hand side of the display will increase and stations will be added to the list. The lower line of the display shows a bar-graph indicating progress of autotune.
5. When the scanning is completed the first station (in numeric-alpha order 0...9...A...Z) will be selected.
6. If the station list is still empty after the scan your radio will display "No stations available".
7. If no signals are found it may be necessary to relocate your radio to a position giving better reception.

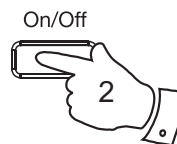

Welcome to DAB  
■■■■■■■■■■

BBC RADIO 7  
Now tuning...

BBC RADIO 7  
Im sorry I have

No stations  
available



## Selecting a station - DAB

1. The top line of the display shows the name of the station currently selected.
2. Press the **Tuning Up/Down buttons** to scroll through the list of available stations.
3. Press and release the **Select button** to select the station. The display may show "Now tuning..." while your radio finds the new station.
4. Adjust the **Volume buttons** to the required setting.

Note: If after selecting a station the display shows "Not Available" it may be necessary to relocate your radio to a position giving better reception.

The use of the station presets for selecting radio stations is described on page 16.

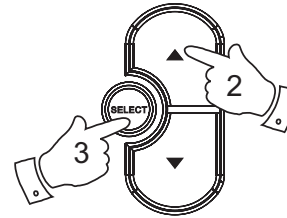

Classic FM

Classic FM  
◆ BBC 7 ◆

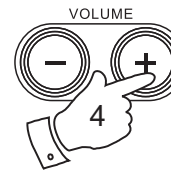

BBC 7  
Now tuning...

## Secondary services - DAB

1. Certain radio stations have one or more secondary services associated with them. If a station has a secondary service associated with it the display will show ">>" next to the station name on the station list. The secondary service will then appear immediately after the primary service as you press the Tuning Up button.
2. Press the **Select control** to select the station.

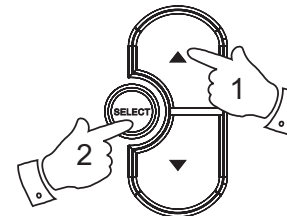

BBC Radio 5  
◆ BBC 5 Live >> ◆

BBC Radio 5  
◆ << BBC Sport ◆

If you need any further advice, please call our Technical Helpline on :-  
020 8758 0338 (Mon-Fri)

## Display modes - DAB

Your radio has seven display modes:-

1. Press the **Info button** to cycle through the various modes.

- |    |                       |  |
|----|-----------------------|--|
| a. | Scrolling text        | Displays scrolling text messages such as artist/track name, phone in number etc. |
| b. | Program Type          | Displays the type of station being listened to e.g. Pop, Classic, News etc.      |
| c. | Multiplex Name        | Displays the name of DAB multiplex to which the current station belongs.         |
| d. | Time and date         | Displays the current the time and date.  |
| e. | Frequency             | Displays the frequency of the DAB multiplex for the station listened to.         |
| f. | Bit rate & audio type | Displays the digital bit rate & audio type for the station being listened to.    |
| g. | Signal Strength       | Displays a graph showing the signal strength for the station being received.     |

● Advanced Info



- |   |                                |
|---|--------------------------------|
| a | BBC RADIO 7<br>Jane Jones Pres |
| b | BBC RADIO 7<br>Varied Speech   |
| c | BBC RADIO 7<br>BBC National    |
| d | BBC 7<br>19:17 08-06-2006      |
| e | BBC RADIO 7<br>12B 225.64MHz   |
| f | BBC RADIO 7<br>160kbps Stereo  |
| g | BBC 7<br>■■■■■□■■■■            |

## Finding new stations - DAB

As time passes new stations may become available. To find new stations proceed as follows:-

1. Press and release the **Auto Tune button**. The display will show "Fast Scanning". Your radio will perform a scan of the UK DAB frequencies. As new stations are found the station counter on the right-hand side of the display will increase and stations will be added to the list.
2. To carry out a full scan of the entire DAB Band III frequencies press and hold down the **Auto Tune button** for more than 2 seconds and then release. As new stations are found the station counter on the right-hand side of the display will increase and stations will be added to the list.

● Full  
AutoTune



Fast Scanning 24  
■■■■■■■■■■

● Full  
AutoTune



Full Scanning 24  
■■■■■■■■■■

## Manual Tuning - DAB

Manual tuning allows you to tune directly to the various DAB Band III channels. UK DAB stations are located in the range 11B to 12D.

1. Press and hold the **Select button** until the display shows "Manual tune". Release the **Select button**.
2. Press either of the **Tuning Up/Down buttons** to select the required DAB channel.
3. Press and release the **Select button** to select the required DAB channel. The clear unfilled rectangle indicates the minimum signal level required for satisfactory reception. The signal strength bar will go up and down showing the changing signal strength as you adjust the telescopic aerial on your radio.
4. When a DAB signal is found, the display will show the name of the DAB multiplex. Any new radio stations found will be added to the list stored in the radio.
5. Press and release the **Select button** to return to normal tuning.

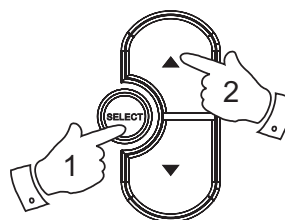

Manual tune

♦ ♦ or SELECT  
♦5A 174.92MHz♦

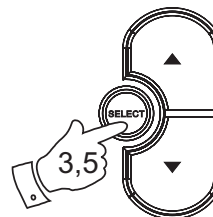

■■■■■  
11D 222.06 MHz

Classic FM  
Now tuning...

## Autoselect - DAB

As an alternative to pressing the **Select button** to select a station your radio can be set so as to automatically select a station.

1. Press and release either the **Tuning Up or Down buttons** then immediately press and hold down the **Select button** until the display shows "Autoselect ON".
2. Press the **Tuning buttons** until the station you require is visible on the display. After a few seconds your radio will automatically select the station shown on the display.
3. To switch off autoselect press and release the **Tuning Up or Down buttons** then immediately press and hold down the **Select button** until the display shows "Autoselect Off".

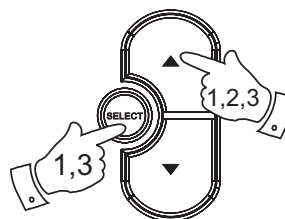

Autoselect ON

Autoselect OFF

## Dynamic Range Control settings - DAB

Dynamic Range Control (also known as DRC) can make quieter sounds easier to hear when your radio is used in a noisy environment.

1. Press the **On/Off button** to switch on your radio.
2. Press and hold in the **Info button**. The display will show "Station order."
3. Press the **Tuning Up/Down buttons** until the display shows "DRC value".
4. Press and release the **Select button** to enter adjustment mode.
5. Press the **Tuning Up/Down buttons** to select the required DRC setting (the default is 0).
  - DRC 0 - DRC is switched off, Broadcast DRC will be ignored.
  - DRC 1/2 - DRC level is set to 1/2 that sent by broadcaster.
  - DRC 1 - DRC is set as sent by broadcaster.
6. Press and release the **Select button** to confirm the setting. The display will return to normal tuning mode.

Note: Not all DAB broadcasts are able to use the DRC function. If the broadcast does not support DRC, then the DRC setting in the radio will have no effect.

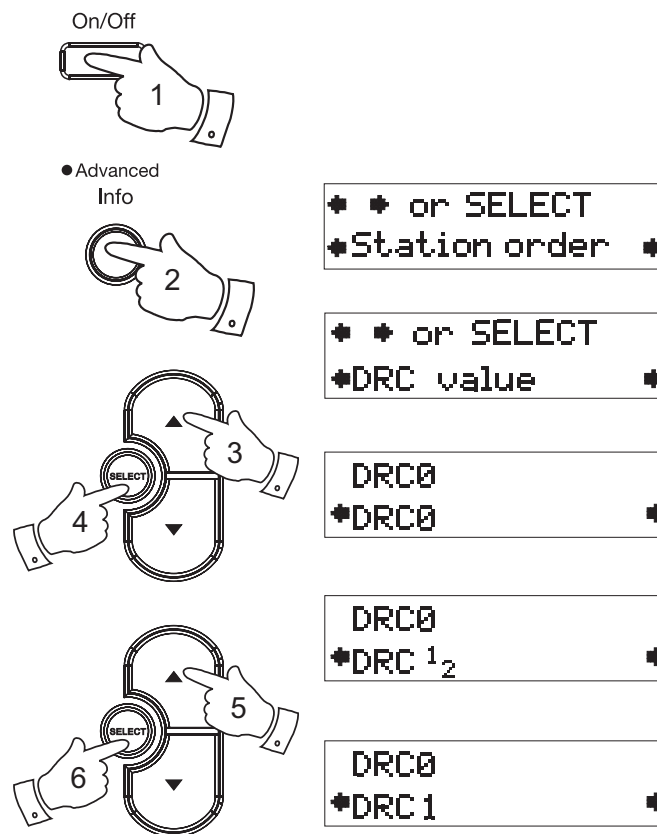

## Operating your radio - FM

1. Carefully extend the telescopic aerial.
2. Press the **On/Off button** to switch on your radio. The display will show "ROBERTS" for a few seconds.
3. Press the **Band button** to select the FM band.
4. Press and release the **Select button** until the display shows "Auto tune <>".
5. Press the **Tuning Up button**. Your radio will scan from the currently displayed frequency direction upwards and will stop scanning when it finds a station of sufficient strength.
6. The display will show the frequency of the signal which has been found. If RDS information is available, after a few seconds the display will show the radio station name. The display will also show "St" and "RDS" on the upper line if the station is received with stereo and RDS information.
7. Press the **Tuning Down button** to scan the FM band in a downwards direction (high frequency to low frequency).
8. When the end of the waveband is reached your radio will recommence tuning from the opposite end of the waveband.
9. Adjust the **Volume control** to the required setting.
10. To switch off your radio press the **On/Off button**.

On/Off

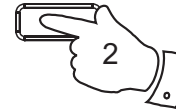

Band



89.30 MHz FM

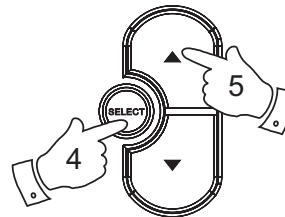

89.30 MHz FM  
Autotune <>

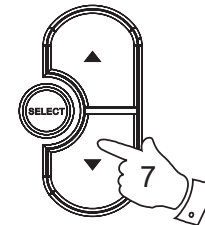

BEC R2 St RDS  
88.10MHz

## Manual tuning - FM

1. Press the **On/Off button** to switch on your radio.
2. Press the **Band button** to select the FM band. Fully extend the **Telescopic aerial**.
3. Press and release the **Select button** until the display shows "Manual tune < >".
4. Press either the **Tuning Up or Down buttons** to tune to a station. The frequency will change in steps of 50kHz. Pressing and holding one of the buttons will advance the frequency selection several times each second.
5. When the end of the waveband is reached the radio will recommence tuning from the opposite end of the waveband.
6. Adjust the **Volume control** to the required setting.
7. To cancel the Manual Tune option, press and release the **Select button** again so that the display shows "Auto tune < >".

On/Off

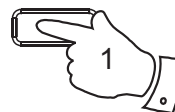

Band



89.30 MHz FM

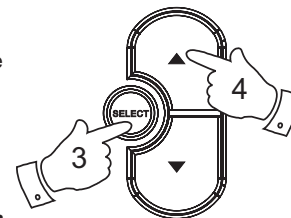

89.30 MHz FM  
Manual tune < >

VOLUME

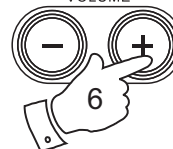

If you need any further advice, please call our Technical Helpline on :-  
020 8758 0338 (Mon-Fri)

## Display modes - FM

In FM mode the bottom line of the display can be set any of four display options.

1. Press the **Info button** to cycle through the various options.

- |                  |  |
|------------------|--|
| a. Radio text    | Displays scrolling text messages such as artist/track name, phone in number etc.                   |
| b. Program Type  | Displays the programme information for the station being listened to e.g. Pop, Classic, News, etc. |
| c. Time and date | Displays the current time and date.  |
| d. Frequency     | Displays the frequency of the station being listened to.   |

Note: These FM mode information displays are only available when the radio is able to receive RDS information from the broadcaster.

● Advanced  
Info



a

```
BBC R2    St RDS
The latest news
```

b

```
BBC R2    St RDS
Pop Music
```

c

```
BBC R2    St RDS
12:02 16-06-2003
```

d

```
BBC R2    St RDS
88.10MHz
```



## Presetting stations - DAB and FM

There are 5 memory presets for each of the two wavebands.

1. Press the **On/Off button** to switch on your radio.
2. Tune to the required station as previously described.
3. Press and hold the required **Preset button** until the display shows, for example, "Preset 1 saved". The station will be stored under the chosen preset button. Repeat this procedure for the remaining presets.
4. Stations stored in the presets may be overwritten by following the above procedure.

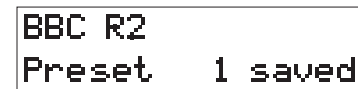
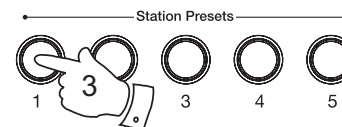
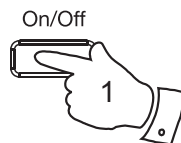

## Recalling a preset - DAB and FM

1. Press the **On/Off button** to switch on your radio.
2. Select the required waveband.
3. Momentarily press the required **Preset button**. Your radio will then tune to the station stored in preset memory.

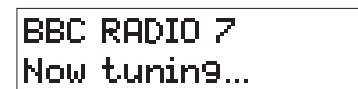
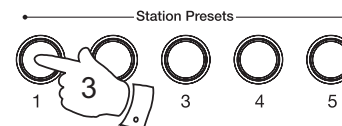
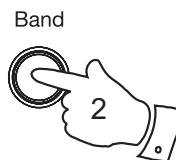

If you need any further advice, please call our Technical Helpline on :-  
020 8758 0338 (Mon-Fri)

## Stereo / Mono setting - FM

Your radio will play stereo broadcasts in stereo (via headphones) so long as the received signal is of adequate strength. However, as a stereo signal becomes weaker the audio signal will become poorer. It may be preferable to force the radio to play the station in mono in order to reduce the level of audio noise.

1. Press the **On/Off button** to switch on your radio.
2. Tune to the required FM radio station as previously described.
3. Press and hold the **Info button** until the display shows "Mono override" on the lower line. The upper line will show "Override Off" if the radio is in the Auto-Stereo mode.
4. Press the **Select button** to switch on the Mono-Override. While this setting is engaged, the radio will play the current station in mono whether listening via headphones or the loudspeaker.

Mono Override is a temporary setting and is applied to the currently tuned station only. It is cancelled automatically by tuning to another radio station.

5. If you wish to cancel Mono-Override while listening to the currently tuned radio station, press and hold the **Info button** until the display shows "Mono override" on the lower line. The upper line will show "Override On" if the radio is in the Mono-Override mode.
6. Press the **Select button** to switch off the Mono-Override. The radio will play then play the current station in stereo through headphones if the signal is sufficiently strong.

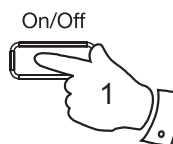

● Advanced Info



BBC R2 St RDS  
88.10MHz

Override Off  
\*Mono Override \*

Override On  
\*Mono Override \*

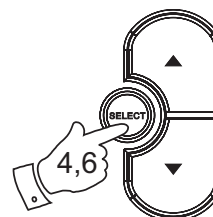

## Scan sensitivity setting - FM

Your radio will normally scan for FM broadcasts which are strong enough to give good reception. However, you may wish the Auto-scan function to also be able to find weaker signals, possibly from more distant radio transmitters. Your radio includes a local / distant option for the Auto-scan function.

1. Press the **On/Off button** to switch on your radio.
2. If needed, press the **Band button** to select the FM band.
3. Press and hold the **Info button** until the display shows "Mono override" on the lower line.
4. Press and release the **Tuning up or down buttons** until the display shows "FM Scan Zone" then press the **Select button** to enter the scan zone selection menu.
5. Press the **Tuning up or down buttons** to switch between Local and Distant options on the lower line of the display. The Distant option will allow the radio to find weaker signals when scanning.
6. Press the **Select button** to confirm your selection. The radio will then revert to the normal information display. The Local or Distant setting is stored in the radio and remains in force until changed or until a System Reset.

Note: The initial setting (out of the box, or after a System Reset) causes the radio to ignore weak (distant) signals.

If you need any further advice, please call our Technical Helpline on :-  
020 8758 0338 (Mon-Fri)

On/Off



1

Band



2

● Advanced Info

Info



3

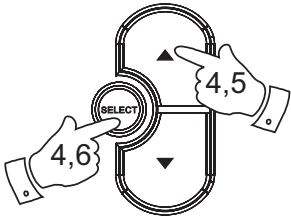

4,6

4,5

BEC R2 St RDS  
88.10MHz

Override Off  
\*Mono Override \*

\* \* or SELECT  
\*FM Scan Zone \*

Scan zone  
\*Local \*

Scan zone  
\*Distant \*

## Software version

The software display cannot be altered and is just for your reference.

1. To view the software version on the display press and hold the **Info button** for 2 seconds.
2. Repeatedly press the **Tuning Up/Down buttons** until "SW Version" together with the version number appears on the display.
3. After a few seconds the display will revert to the normal display mode.

## System reset

If your radio fails to operate correctly, or some digits on the display are missing or incomplete carry out the following procedure.

1. Press and hold down the **Info button** for 2 seconds
2. Repeatedly press the **Tuning Up/Down buttons** until the display shows "Factory reset", then press the **Select button**.
3. If you wish to perform the reset operation, press the **Select button one more time**. A full reset of your radio will be performed. All presets and station lists will be erased.
4. After a system reset a scan of the DAB band will be performed.  
In case of malfunction due to electrostatic discharge, reset the product (reconnection of power source may be required) to resume normal operation.

**If a problem persists our technical staff would be pleased to offer any assistance on operating the radio. Our technical helpline number is 020 8758 0338.**

● Advanced  
Info



Software v1.35.2  
\*Sw version \*

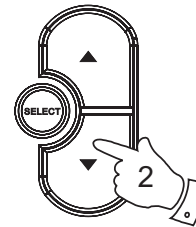

● Advanced  
Info



\* \* or SELECT  
\*Factory reset \*

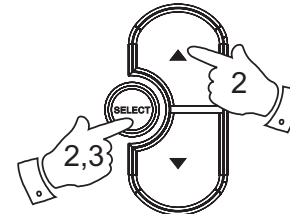

Press SELECT to  
confirm reset...

Welcome to DAB  
■■■■■■■■■■

## Headphone socket

A 3.5mm **Headphone Socket** located on the left hand side of your radio is provided for use with either headphones or an earpiece. Inserting a plug automatically mutes the internal loudspeaker.

**IMPORTANT:** Excessive sound pressure from earphones and headphones can cause hearing loss.

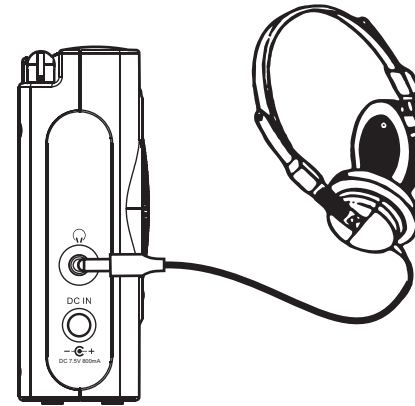

---

## Display backlight

1. When using on batteries, the display backlight will be switched on for approximately 12 seconds when any button is pressed.
2. When your radio is powered by AC mains the display backlight will always be on when the radio is switched on.

*If you need any further advice, please call our Technical Helpline on :-  
020 8758 0338 (Mon-Fri)*

## A Few Words about Batteries...

Your Roberts ecologic 1 radio has been designed to use a choice of power sources. You may plug it into the mains using the supplied high-efficiency adaptor, or for listening away from the mains you may use either alkaline or rechargeable batteries. We do not recommend the use of carbon-zinc or zinc-chloride batteries.

**It is very important that you read the advice and warnings given below.**

- 1) Whichever type of batteries you choose to use, it is very important that the battery selection switch under the cover is set to the correct type.
  - a. If no batteries are fitted, then set the switch to the Alkaline position (to the left as viewed from the back of the radio). This position minimises the power consumption when the radio is powered from the mains.
  - b. If Alkaline batteries are fitted, then set the switch to the Alkaline position (to the left as viewed from the back of the radio).
  - c. If Rechargeable batteries are fitted, then set the switch to the NiMH position (to the right as viewed from the back of the radio). Your radio is designed to use Nickel-Metal-Hydride rechargeable batteries. No other type of rechargeable battery should be used in the radio.
- 2) **NEVER** mix old and new Alkaline batteries. The old batteries may suffer damage and leak which will damage your radio and whatever the radio is standing on.
- 3) **NEVER** mix old and new Rechargeable batteries. This may result in unreliable charging and shortened battery life. Never mix Rechargeable batteries of different types or capacities even if they are new.
- 4) **NEVER** mix Alkaline and Rechargeable batteries. The recharging of Alkaline batteries can be very dangerous.

## Rechargeable batteries

Your ecologic 1 radio uses a range of methods to ensure correct and safe charging of Rechargeable Nickel-Metal-Hydride batteries. These work to protect your batteries from excessive charge and discharge. These protections can only work properly if the advice above is followed. In particular, the radio will not be able to correctly charge batteries if they are a mixture of different brands, or different ages, or different capacities.

We recommend that all the rechargeable batteries used in your radio are bought together as a set. They should always be charged together and discharged together and not "borrowed" from time to time for other applications. This will ensure that they give their optimum performance in your radio.

We recommend that the rechargeable batteries that you use should be from a quality brand, and should be of at least 2000mAh capacity. Batteries of this capacity should be able to power your radio for between 10 and 20 hours depending upon the volume of the radio, whether DAB or FM mode is used (DAB mode uses slightly less power than FM), and also depending on the condition of the batteries.

Before you first install a new set of rechargeable batteries into your radio you should first make sure that the battery type switch beneath the battery cover is in the NiMH position. Install the batteries arranging them as shown on the back of the radio. Plug the mains adaptor into a mains socket and then into the radio. While the batteries are charging the battery indicator should show a flashing green light. When the batteries are fully charged the indicator will stop flashing and will show a steady green light. The time taken to charge the batteries will depend on how much charging they require. New batteries may be partly charged when first fitted, but it is normal for a set of batteries to take several hours to charge fully (this can be between 5 and 8 hours depending on the battery capacity and their initial state of charge).

If you use the radio powered from the batteries, the battery light will be off until the batteries are exhausted. The battery light will then show red for a short while before the radio switches itself off. It does this in order that the batteries are not excessively discharged. This would otherwise damage the batteries and shorten their life.

If you use the radio powered from the mains with rechargeable batteries fitted, the charging process is suspended until you switch off the radio. When you switch off the radio using its On/Off button charging will then resume. If the batteries have already been charged then they will only charge for a few more minutes before the battery indicator stops flashing.

If you only listen to your radio for short periods, you do not need to connect your radio to the mains to charge the batteries every time that you use it. However, if the radio is not to be used for a few weeks, then we recommend that the batteries are fully charged (battery light shows steady green) before the radio is put to one side.

If you intend not to use your radio for some months, then we recommend that the batteries are removed and put away, keeping them in a cool place out of reach of children, away from moisture and such that no metal object can contact the battery terminals.

With care, rechargeable batteries can last a long time and can operate for many hundreds of charge and discharge cycles. When your rechargeable batteries can no longer power your radio adequately, please dispose of them thoughtfully.

### **To avoid danger and risk of injury, please follow these guide lines**

Improper use of batteries may result in leakage of fluid, overheating or explosion. Battery fluid is corrosive and may also be toxic. Battery fluid can cause skin burns, can damage the eyes, and can be harmful if swallowed.

1. Keep batteries out of the reach of children.
2. Do not heat, open, puncture, mutilate or dispose of batteries by burning.
3. Do not mix different battery types or old and new batteries. Always replace all the batteries at the same time.
4. Do not carry or store batteries such that metal objects may contact the end caps.
5. Remove batteries from the radio if they are worn out or if you are storing it for a long time.
6. Remove old or worn out batteries promptly, and recycle or dispose of them according to the regulations applicable to your location.
7. If a battery does leak, remove all batteries from the product, taking care to avoid directly touching the leaked fluid. If the fluid contacts skin or clothes wash with water immediately. Before inserting new batteries, thoroughly clean the battery compartment with a damp paper towel, or follow the battery manufacturer's advice for clean up.

## General

Do not allow this radio to be exposed to water, steam or sand. Do not leave your radio where excessive heat could cause damage such as in a parked car where the heat from the sun can build up even though the outside temperature may not seem too high. It is recommended that the DAB band be used wherever possible as better results in terms of quality and freedom from interference will usually be obtained than on the FM band.

The name plate is located on the back of your radio.

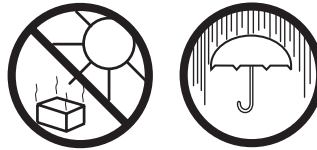

- Your radio should not be exposed to dripping or splashing and that no objects filled with liquids, such as vases, shall be placed on the radio.
- It is recommended to operate the product such that there is a minimum distance (10cm recommended) to adjacent objects in order to ensure good ventilation.
- The ventilation of the product should not be restricted by covering it or its ventilation openings with items such as newspapers, tablecloths, curtains etc.
- No naked flame sources such as lighted candles should be placed on the product.
- It is recommended to avoid using or storing the product at extremes of temperature. Avoid leaving the unit in cars, on window sills, in direct sunlight etc.

## Specifications

### Power Requirements

Mains AC 100  $\sim$  240V 50/60 Hz (switching adaptor)  
Batteries 4 x LR6 (AA size) Alkaline or NiMH rechargeable

### Battery Life

Up to 25 hours of listening when used for 4 hours a day at normal volume using alkaline cells.

### Frequency Coverage

FM 87.5-108MHz  
DAB 174.928 - 239.200MHz

## Circuit Features

Loudspeaker 75mm  
Output Power 0.5 Watt  
Headphone socket 3.5mm dia  
Aerial System FM Telescopic aerial  
DAB Telescopic aerial

*The Company reserves the right to amend the specification without notice*



## Guarantee

This instrument is guaranteed for twelve months from the date of delivery to the original owner against failure due to faulty workmanship or component breakdown, subject to the procedure stated below. Should any component or part fail during this guarantee period it will be repaired or replaced free of charge.

The guarantee does not cover:

1. Damage resulting from incorrect use.
2. Consequential damage.
3. Receivers with removed or defaced serial numbers.

N.B. Damaged or broken telescopic aerials will not be replaced under guarantee.

Procedure:

Any claim under this guarantee should be made through the dealer from whom the instrument was purchased. It is likely that your Roberts' dealer will be able to attend to any defect quickly and efficiently but should it be necessary the dealer will return the instrument to the Company's service department for attention. In the event that it is not possible to return the instrument to the Roberts' dealer from whom it was purchased, please contact Roberts Radio Technical Services at the address shown on the rear of this manual.

*These statements do not affect the statutory rights of a consumer.*

*If you need any further advice, please call our Technical Helpline on :-  
020 8758 0338 (Mon-Fri)*







Issue 1

## ROBERTS RADIO TECHNICAL SERVICES

97-99 Worton Road

Isleworth Middlesex

TW7 6EG

Technical Helpline :- 020 8758 0338 (*Mon-Fri during office hours*)

Website: <http://www.robertsradio.co.uk>

